

The logo for Hurlcon, featuring the word "hurlcon" in a bold, black, sans-serif font. A blue arc is positioned above the letters "u" and "l", and another blue arc is positioned below the letters "c" and "o".

Hurlcon Gas Fired Hot Water Boiler H120 & H150 S & B Models

INSTALLATION AND OPERATING INSTRUCTIONS



HURLCON Manufacturing & Sales Pty. Ltd. A.B.N. 97 007 284 504
48 Hanna Street, Noble Park, VICTORIA. 3174
Telephone: (03) 9554 2200 Facsimile: (03) 9554 2270
www.hurlcon.com.au email: service@hurlcon.com.au

Information and specifications subject to change without notice.

INSTALLATION AND OPERATING INSTRUCTIONS	1
1.0 INTRODUCTION	3
1.1 NOTICE TO INSTALLERS	3
2.0 MODELS AVAILABLE	4
2.1 STANDARD EQUIPMENT.....	4
3.0 INSTALLATION	5
3.1 SAFETY RULES.....	5
3.2 GUIDE TO INSTALLATION.....	6
3.3 CLEARANCES	7
3.4 ELECTRICAL CONNECTION	7
3.5 BOILER DIMENSIONS	8
3.6 INDOOR INSTALLATION.....	8
3.7 VENTILATION – AIR SUPPLY TO THE BOILER.....	9
3.8 HEATING PIPE SIZE & LAYOUT	10
3.9 SIZING OF PRESSURE VESSEL	10
4.0 COMMISSIONING	11
4.1 STARTING BOILER.....	11
4.2 TESTING BURNER PRESSURE.....	11
4.3 FLOW SWITCH.....	11
4.4 GENUS IV 3 BUTTON CONTROLLER.....	12
5.0 OPERATING INSTRUCTIONS	12
5.1 ENERGY SAVING TIPS.....	13
5.2 MAINTENANCE	13
5.3 CONTROL SYSTEMS	13
6.0 GAS CONVERSION.....	15
6.1 BURNER CONVERSION	15
6.2 GAS – COMPONENT INFORMATION	16
6.3 GAS PIPE SIZING TABLES	16
7.0 TROUBLESHOOTING	17
8.0 H120 – H150 WIRING DIAGRAM.....	18
8.1 MODEL H120 – H150 WITH HEATSAVER	18
9.0 ONE YEAR LIMITED WARRANTY.....	19

1.0 INTRODUCTION

Congratulations on your purchase of a Hurlcon H120 - H150 Series Hot Water Boiler. Correct installation and service of your new heating system and correct chemical maintenance of the water will ensure years of service. The H120 - H150 Series Boiler is a compact lightweight and efficient gas fired hot water boiler. It is equipped with features that take advantage of new technology developed exclusively by Hurlcon.

The Hurlcon Boiler is a floor mounted atmospheric boiler with a built in balanced flue for outdoor installation. The power output is controlled by an integrated electronic controller to maintain the set point water temperature over a wide load range. In addition, the Hurlcon Boiler is equipped with electronic ignition. The electronic display tells at a glance the operational status of the boiler.

1.1 NOTICE TO INSTALLERS

This is a Floor Mounted - External – Hot Water Boiler
For use with Natural Gas or LP Gas as per the attached data label.

The information below is given to assist the installer with the installation of this range of H120 – H150 Boilers. Please read it carefully in order to make the installation as easy as possible and to ensure the system works well and conforms to the necessary government regulations.

PLEASE READ THESE INSTRUCTIONS BEFORE STARTING THE INSTALLATION.

It is important that this boiler is installed and serviced as detailed in these instructions by an
AUTHORISED person.

This boiler is to be installed and serviced to the requirements of the
Local Building, Gas, Water and Electricity Authorities.

These instructions are to be held by the owner / user after installation.

This boiler **must not** be used as a SPA or POOL Heater

This appliance must be installed in accordance with the installation instructions, local gas fitting regulations, the AGA Installation Code AG 601 and any other relevant statutory authorities.

Refer to data plate for details of gas type, gas consumption and burner pressure.

2.0 MODELS AVAILABLE

Details	Model 120S & 120B	Model 150S & 150B
Height	900	900
Length	510	640
Width	390	
Gas input	105 MJ	144 MJ
Gas type	Natural & L P Gas	
Nom output	24 kW (82,000Btu)	35 kW (119,000Btu)
Ignition system	Electronic Ignition	
Heat exchanger/burner	All copper/stainless steel	
Boiler Thermostat	<i>digital</i> Electronic Genus 1V	
Pressure relief	300kPa (3 Bar)	
Expansion vessel	7 litre diaphragm (~60lt system)*	
Circulator	In line Centrifugal Pump*	
Hi limit Thermostat	100 °C manual reset	
Run on timer	Electronic temperature and time based.	
Pressure reduction valve	1 Bar pre-set *	
Packed weight	50kg	60kg

2.1 STANDARD EQUIPMENT

Electronic control including.

- Displays set and flow temperature.
- Electronic ignition

Safety devices

- Built in flow switch
- Built in run on timer
- Manual reset high limit

Built to last

- All copper double row heat exchanger
- Stainless steel burners
- Fully powder coated steel cabinet
- Powder coated flue terminal

Efficiency

- Hot surface ignition
- Highly efficient stainless steel burners

Ease of installation

- Fully plumbed ready to go, including circulator*, expansion tank*, pressure reduction valve* & 1” flow – return isolation valves.
- All electrical pre wired including three pin power supply.

(* not supplied with ‘B’ model boiler)

3.0 INSTALLATION

THIS APPLIANCE MUST BE INSTALLED BY AN AUTHORISED PERSON.

Refer to boiler data plate for specifications of gas type, gas consumption, burner pressure and water pressure.

This appliance must be installed in accordance with local regulations and A.G.A. Installation Code AG 601.

The flow and return connections are located on the rear of the boiler. The flow and return connections are clearly marked and the connections are 1" BSP FI.

The Hurlcon Boiler is fitted with a built in flow switch and will not start unless full of water and the pump is operating.

The Hurlcon Boiler incorporates a balanced flue terminal and is suitable for outdoor installation. An internal model is available on request.

3.1 SAFETY RULES

For your safety – read before lighting

This appliance is equipped with an ignition device, which automatically lights the burner. Do not try to light the burner by hand.

BEFORE OPERATING smell all around the appliance area for gas. Be sure to smell next to the floor because some gas is heavier than air and will settle on the floor.

Safety

WHAT TO DO IF YOU SMELL GAS

- Do not try to light any gas appliance.
- Do not touch any electrical switch.
- Turn off the gas supply at the gas meter.
- Immediately call your gas supplier or licensed gas fitter.

NOTE. Some gases are heavier than air and it may be necessary to smell for leaks at floor level.

House keeping

- Do not store or use flammable liquids or chemicals near this appliance.
- Do not use aerosols in the vicinity of this gas appliance.
- Keep this appliance free of debris.

WARNING:

Should overheating occur or the gas supply fail to shut off, turn off the manual gas control valve to the appliance.

Do not use this boiler if any part has been under water.

3.2 GUIDE TO INSTALLATION

Location of Flue Terminals – An extract from AG 601

Minimum Clearances Required For Balanced Flue Terminals or The Terminals Of Outdoor Appliances.

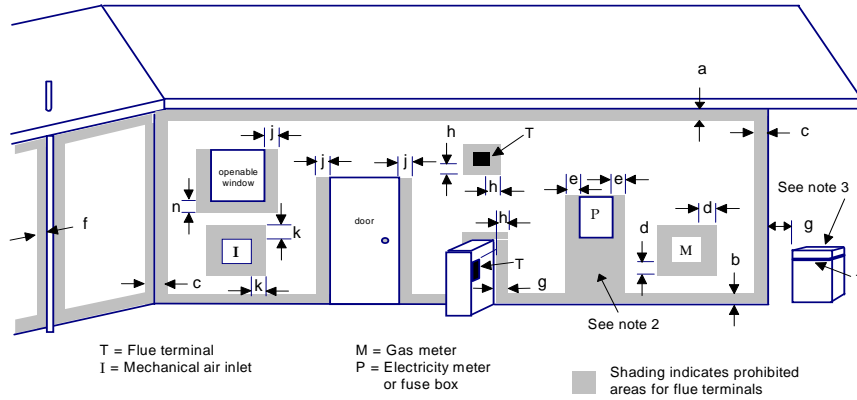

MIN. CLEARANCE (mm)

A	Below eaves, balconies and other projections	
	Appliances up to 50 MJ/h input	300
	Appliances over 50 MJ/h input	500
B	From the ground, <u>above a balcony or</u> other surface	300
C	From a return wall or external corner	500
D	From a gas meter (M)	1000
E	From an electricity meter or fuse box (P)	500
F	From a drain pipe or soil pipe	150
G	Horizontally from any building structure (unless appliance approved for closer installation) or obstruction facing a terminal	500
H	From any other flue terminal, cowl, or combustion air intake	500
I	Horizontally from an openable window, door, non-mechanical air inlet, or any other opening into a building with the exception of sub-floor ventilation	500
	Appliances up to 150 MJ/h input	500
	Appliances over 150 MJ/h input (natural draught)	1500
	Appliances over 200 MJ/h input	1500
	All fan-assisted flue appliances, in direction of discharge	1500
K	From a mechanical air inlet, including a spa blower	1500
N	Vertically below an openable window, non-mechanical air inlet, or any other opening into a building with the exception of sub-floor ventilation	See table

Deleted:

Deleted:

Deleted:

Deleted:

Deleted:

CLEARANCE 'n' (mm)			
Space heaters	All other appliances		
Up to 50 MJ/h input	Up to 50 MJ/h input	Over 50 MJ/h & up to 150 MJ/h	Over 150 MJ/h input
150	500	1000	1500

Deleted:

Deleted:

NOTES: 1

All distances are measured to the nearest part of the terminal.

2 Prohibited area below electricity meter or fuse box extends to ground level.

3 See Clause 5.13.6.6 for restrictions on a flue terminal under a covered area.

4 See Appendix J, Figures J1(a) and J2(a), for clearances required from a flue terminal to an LP Gas cylinder. A flue terminal is considered to be a source of ignition.

The above information is part of AG 601 FIGURE 5.3 as supplied by the AGA and is provided as an indication of the correct clearances only. Please refer to the latest issue of AG 601.

3.3 CLEARANCES

The boiler must be installed at least 500mm from any combustible surface. Clearances must comply with AG 601.

Clearances from non combustible surfaces are:

Front	500mm
Both sides	500mm
Rear	80mm
Above	1500mm
Combustible Surfaces	500mm Minimum

Boiler must be installed on a fireproof base.

3.4 ELECTRICAL CONNECTION

The boiler is supplied with a standard 10 amp 3 pin plug for connection to a 240V 10 amp GPO. The boiler incorporates a 240/24 VAC transformer which supplies power to the control circuit only and must not be used for any additional equipment. All equipment connected to mains power should be protected by an RCD circuit breaker. The boiler has a 240 volt power supply for the pump electrical connection which incorporates the pump run on feature. A terminal strip is provided for a 24 volt room thermostat.

To enable temperature set-back, cut the blue wire loop at the 4 way connector attached to the control board. Extend the blue wires to a remote switch or timer with volts free contacts. With contacts closed, Set 1 is enabled. With contacts open, Set is enabled.

If the supply cord is damaged, it must be replaced by the manufacturer or its service agent or a similarly qualified person in order to avoid a hazard.

3.4.1 GAS CONNECTION

A ¾" BSP FI is provided for gas line connection. An approved manual shut off valve must be installed in the gas fitting line before the boiler so that the gas can be turned off and the boiler removed for servicing if required. The gas shut off valve should be sized the same as the gas fitting line to prevent excessive pressure drop in the gas pipe.

The gas fitting line should be installed by an authorised person and comply with local regulations and A.G.A. code AG 601. The gas line from the meter will usually be of a larger size than the gas inlet connection. Therefore a reduction to the boiler connection fitting will be necessary. The reduction should be as close to the boiler as possible.

Before using the boiler, test all connections for gas leaks using soapy water.

The boiler gas valve has a built in pressure regulator with a 1/8" pressure test point provided. On starting the boiler, a manometer must be used and burner pressure checked against the boiler data plate. The gas valve regulator may need adjustment to correct manifold pressure. Incorrect burner pressure may void warranty.

3.5 BOILER DIMENSIONS

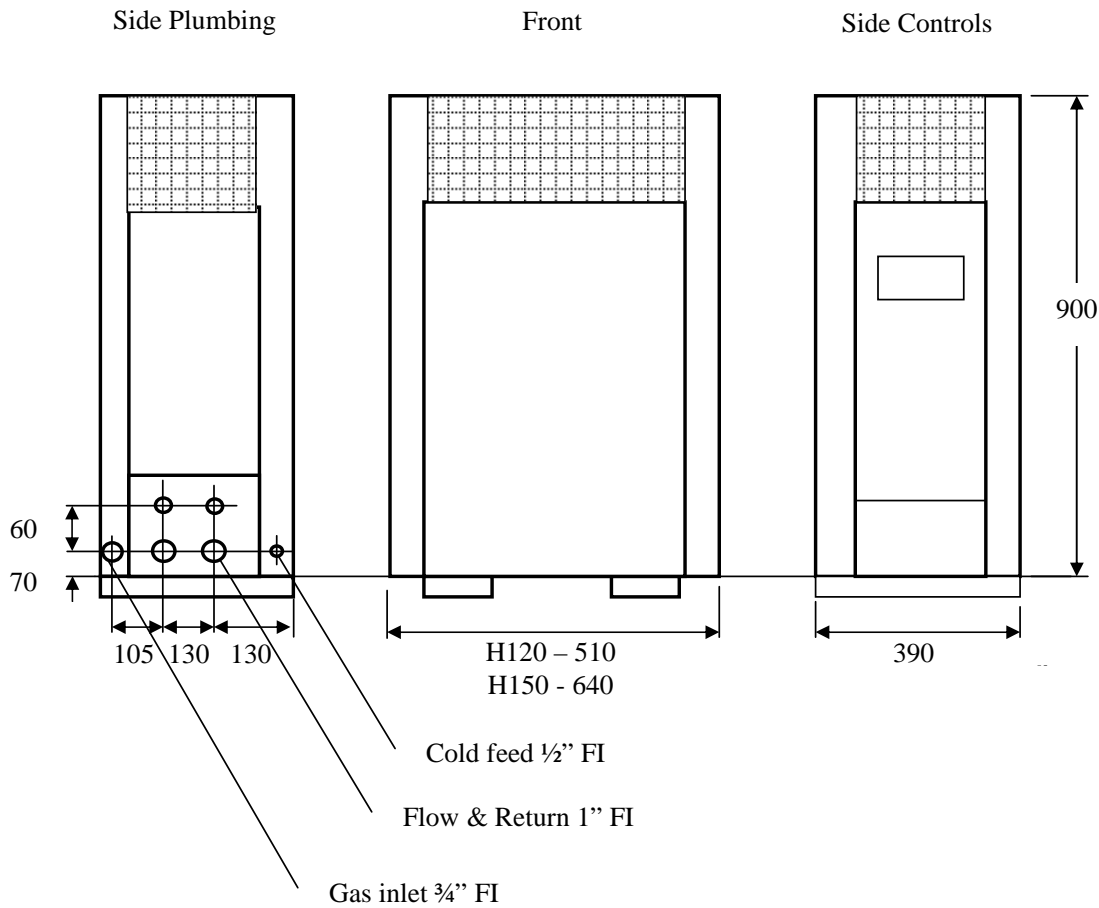

3.6 INDOOR INSTALLATION

If the H120 - 150 Boiler is to be installed indoors, an indoor draught hood kit must be purchased from Hurlcon and installed on the Boiler to convert it to an indoor model.

Product code numbers for draught hoods are:

Boiler model	Indoor top model	Flue size	Part number
H120	DH 12	125 mm	10134
H150	DH 15	150mm	10970

A flue no smaller than the draught diverter diameter must be installed and terminated with an approved gas flue cowl (not a Chinaman's hat) 600mm above any roofline that is within 1.5 metres horizontally from the flue.

3.7 VENTILATION – AIR SUPPLY TO THE BOILER

When installing the boiler indoors, it is imperative that an adequate supply of fresh air is provided for combustion. Failure to provide adequate ventilation voids all warranties and may be a danger to persons or property. Please refer to AG 601 for full details.

Two permanent openings shall be provided directly to outside. The openings shall be located to ensure the distance between the top of the upper opening and the ceiling of the room or enclosure, and the distance between the bottom of the lower opening and the floor of the room or enclosure does not exceed 5% of the height of the room or enclosure.

The minimum vertical dimension of any free ventilation opening shall be 6 mm.
The minimum free ventilation area provided by each opening shall be:

MODELS	H120	H150
AREA mm ²	35,000	50,000

The following diagram is provided as a guide only. All fluing and installation work must be carried out by an authorized person. Fluing must conform to local regulations and to A.G.A. installation code AG 601. Care must be taken to provide the correct ventilation and correct fluing materials in close proximity to combustible surfaces.

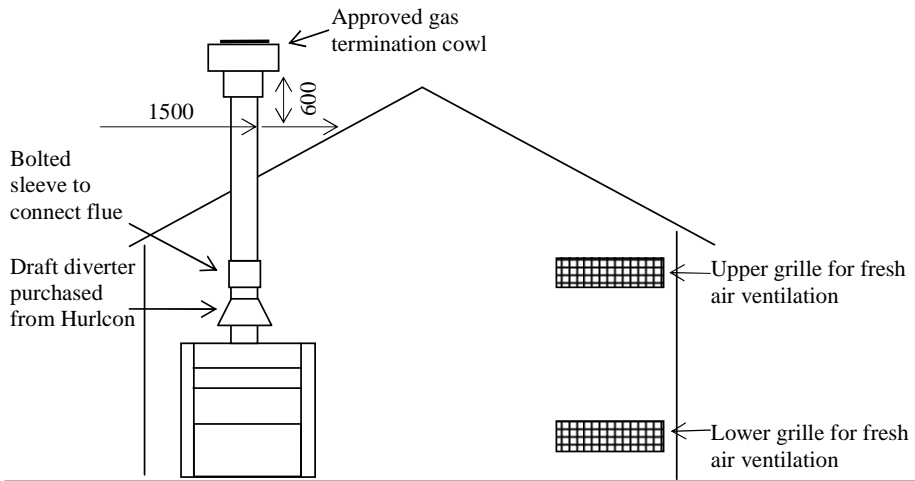

A Hurlcon indoor draught diverter must be fitted to unit in accordance with Hurlcon’s Instructions and Installation Codes before the boiler can be enclosed.

Do not install spa blowers in the same room as a gas boiler. This is potentially dangerous to spa users.

Do not store chemicals or fuel in the same room as the gas boiler. This may cause fire or explosion.

When installing in a garage the H120 – 150 Boiler must be installed 450 mm above floor level.

3.8 HEATING PIPE SIZE & LAYOUT

- The flow & return connection sizes of 1”BSP on the boiler are not necessarily the correct pipe sizes for the heating system. It is important that the pipe sizes are correctly calculated before installation.
- Hurlcon recommend a two pipe system with the pipes sized according to the flow requirements and length of runs with a maximum water velocity of 1.5 M/s.
- Reference The Institute of Plumbing Australia. - “SELECTION & SIZING OF COPPER TUBES FOR PIPING SYSTEMS”.

Nominal flow capacities

Model	Output	Flow rates	DT	pd	min Pipe dia	F & R length
120	24 kW	0.38 l/s	15 °C	8 kPa	20 mm	6.0 m
150	35 kW	0.53 l/s	15 °C	14 kPa	25 mm	4.5 m

Typical two pipe system

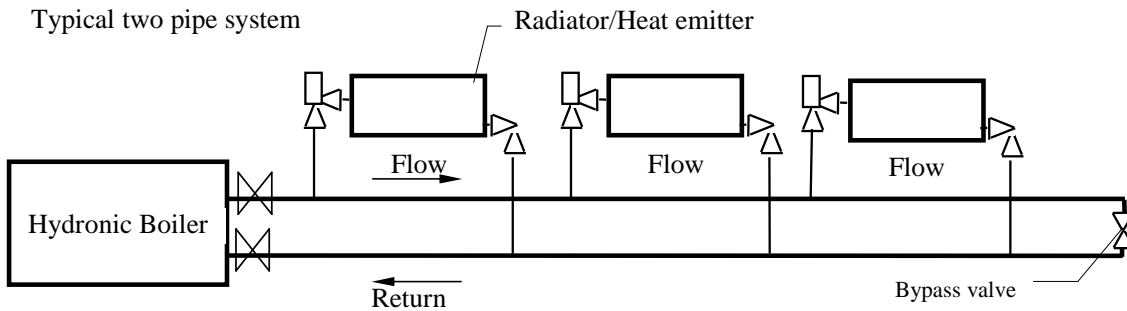

Notes

1. An automatic heating bypass valve should be fitted to maintain adequate flow rate through the boiler when thermostatic valves are fitted and or when the majority of radiators are required to be turned off for long periods of time.
2. Any pipe work that is in an unheated area such as under the floor or in the ceiling space should be suitably insulated to prevent heat loss and possible freezing of the pipes.
3. The pipe work should be graded to facilitate the elimination of air at the highest point and the draining of the system at the lowest point. Provide air bleeds and drains at these points.

3.9 SIZING OF PRESSURE VESSEL

If the total water capacity of the heating system is greater than 60 litres then an additional pressure vessel should be fitted. An approximate figure can be calculated from the following table. An additional tank can be fitted at a convenient location on the system if required.

Item	Capacity litres	per
Therma rad Radiators	0.70	kW
Thermaboard single	0.22	metre
Thermaboard double	0.44	metre
Copper tube 25 mm	0.44	metre
Copper tube 20 mm	0.23	metre
Copper tube 15 mm	0.10	metre

4.0 COMMISSIONING

4.1 STARTING BOILER

- Fill system with water and purge all air from system and pump.
- Purge gas line of any air and wait five minutes for gas to clear.
- Plug three pin plug into a suitable power point and switch on. Digital controller should now operate and indicate water temperature.
- Pump should start, the flow symbol should be displayed.
- Turn controller switch ON.
- After a few seconds, the burner should ignite. (Do not light by any other means.)
- If the burner fails to light, check flow indicator is on. Turn controller switch OFF for 5 seconds then ON to reset ignition system. (Trouble shooting page 19.)
- Allow boiler to run. Check there are no leaks and there is flow to all of system.

4.2 TESTING BURNER PRESSURE

- Set up manometer
- Turn boiler “OFF”.
- Remove screw from 1/8” brass test point located on outlet side of gas valve.
- Connect manometer tube to test point
- Turn boiler “ON” and wait for main burner to ignite.
- Once main burner has ignited, the manometer must indicate the nominal burner pressure listed below.
- To adjust gas valve regulator, remove regulator adjustment cap and, using a screwdriver, turn plastic bush clockwise to increase, anti-clockwise to decrease burner pressure.
- **Check all gas connections are tight and not leaking.**

Maximum inlet gas pressure is:

Natural Gas 3.5 kPa Propane Gas 3.5 kPa ULPG 3.5 kPa

Nominal burner pressure is:

	H120	H150
Natural Gas kPa	0.82	0.82
Propane Gas kPa	2.50	2.50
ULPG kPa	2.00	2.00

4.3 FLOW SWITCH

- The Hurlcon Boiler has an inbuilt flow switch which allows the burner to operate only when the system is full of water and the circulating pump is operating. NOTE: The installed flow switch has no user adjustments.
- Air in the system may stop the boiler from lighting.

4.4 GENUS IV 3 BUTTON CONTROLLER

- **90° or 55° operation.** H series boilers are set factory default 90°. For floor heat applications the boiler can be selected for 55° max setpoint by a jumper on the PCB. (See page 18).
- **Hurlcon Genus IV room thermostat.** If a Hurlcon Genus IV room thermostat is fitted the Genus boiler control will 'learn' automatically when powered up after approx 1 minute. If the thermostat is disconnected or loses communication F5 fault will be displayed and the boiler will shut down after 3 minutes. To change thermostat type see table below. The thermostat selector switch will also need to be set, see page 18.
- **Switching differential.** The temperature switching differential can be adjusted to stop short cycling. See table below for appropriate codes. (Default 5°.)
- **°F or °C.** The display can be toggled between Celsius and Fahrenheit. See table below for codes. (Default °C.)

With the unit switched off, press and hold the on/off button then press the following.

	Button presses			
	1	2	3	4
Degrees C	U	D	D	D
Degrees F	U	D	D	U
Genus IV thermostat	U	D	U	D
Standard thermostat	U	D	U	U
5 ° differential	D	D	D	U
10 ° differential	D	D	U	D
15 ° differential	D	D	U	U
20 ° differential	D	U	D	D

U = warm button D = cool button

5.0 OPERATING INSTRUCTIONS

- STOP! Read the safety rules on page 5 section 3.1.
- Turn off electric power to appliance.
- This appliance is equipped with an ignition device, which automatically lights the burner. Do not try to light the burner by hand.
- Wait five minutes to clear out any gas. If you then smell gas, STOP! Refer to instructions above.
- Turn on power to appliance.
- Set thermostat to desired setting and press ON/OFF switch to ON. The boiler will ignite in around 10 seconds
- If the appliance will not operate, press ON/OFF switch to OFF then ON again. If the appliance still does not ignite, check trouble shooting on page 19 or call your service technician.

TO TURN GAS OFF TO APPLIANCE

- Turn off all electrical power to the appliance.
- Turn off gas tap in gas line prior to boiler.

5.1 ENERGY SAVING TIPS

- During extended periods of non use, turn the boiler off.
- Set up a regular program of preventative maintenance for the boiler. Check heat exchanger, controls, burner operation etc.
- For areas where there is a danger of freezing, water should circulate through your boiler even if the heating is off.

5.2 MAINTENANCE

- It is recommended that the following items are professionally checked at least every six months and at the beginning of every heating season.
- Examine the balanced flue or indoor draught diverter. Make sure there are no obstructions to the flow of air to, or flue products from, the appliance.
- Visually check the main burner and pilot flames. If the flame appears yellow, the burner should be cleaned by a qualified service technician.
- Keep the boiler area clear and free of combustibles and flammable liquids. Chlorine should not be stored in the vicinity of the boiler. Chlorine vapours, when drawn through a boiler, can rapidly cause corrosion of the heat exchanger.
- Keep the boiler area free from garden refuse and debris. This will help prevent insects nesting in the unit and ensure extended life and reliability of your boiler.

5.3 CONTROL SYSTEMS

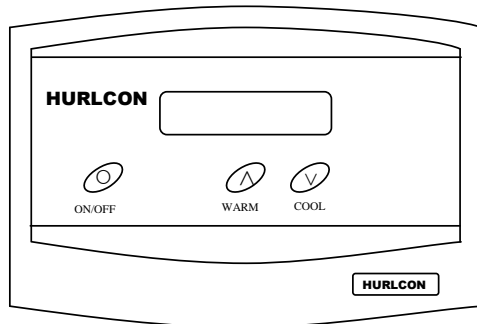

5.3.1 DESCRIPTION

The sophisticated digital thermostat provides temperature read out, set point temperature and operating status of the boiler. The electronic display indicates the operational status of the boiler and any fault conditions.



5.3.2 TEMPERATURE DISPLAY

- The temperature display indicates water temperature in the outlet (flow) of the boiler. Therefore the pump must be operating for an accurate water temperature to be displayed.
- Water temperature can be set between 55°C to 90°C. (35°C to 55°C floor heat). To select your desired water temperature press the up or down button repeatedly until the desired temperature is reached.
- Fitting of an external switch allows temperature set-back via two adjustable set points. (See section

- To prevent rapid cycling of the boiler, the thermostat has an inbuilt time delay which prevents the boiler from turning on for two minutes after the set point has been reached. If the time delay is activated, the symbol “L” will be displayed. This is part of normal operation.
- The thermostat can be set to temperatures between 55°C to 90°C. (35°C to 55°C floor heat). It also incorporates several safety features including a 100°C high limit function to prevent overheating. On simultaneous shut down of the circulating pump and boiler, the water within the boiler may exceed the set temperature for a short period. If the pump and boiler are restarted during this period, the thermostat will go into a standby mode and prevent the boiler from relighting until the temperature within the boiler has dropped below the set temperature.
- If the optional set-back function is used, both set points (Set, Set 1) need to be adjusted independently. These are each adjustable over the full thermostat range.
- Should the thermostat fail to stop the boiler at the set point or at 100°C, there is a manual reset temperature limiting safety device designed to lock the boiler out and prevent further heating. Plus a lock out condition is indicated by the symbols F1 or F2. To reset a lock out condition, turn the controller off for five seconds. An F2 condition will first require the mechanical safety device to be reset. To do this, remove the rear access panel and press the red button. If the boiler has cooled sufficiently, a positive “click” should be heard and felt.

5.3.3 FAULT INDICATION

Under fault conditions the thermostat display will indicate a set of alpha numeric symbols to indicate the status of the boiler. The meaning of each symbol and action to be taken are listed as follows:

SYMBOL	MEANING	ACTION
Temp Display	Unit has power.	No action
F0	Boiler locked off, thermistor wire is disconnected or water at 0°C (freeze conditions).	If water temperature reads greater than 0°C, turn off/on if problem persists phone for service.
F1	Thermostat reads greater than 100°C or thermistor short circuited.	Allow water to cool, turn boiler off then on again.
F2	Mechanical Hi Limit greater than 100°C.	Allow water to cool, reset Hi Limit, turn boiler off then on again.
F5	Thermostat communication fault	Check connections. Check thermostat ‘type’ setting is correct.
L	Boiler locked out on time delay	No action. Boiler will delay for 2 minutes Automatically reset after time delay. Or switch off then on again for immediate ignition.
	Pump operating & sufficient water flow to operate boiler	No action.
	Thermostat calling for heat operating.	No action, boiler electronic ignition should ignite in a few seconds.
	Burner system has ignited and is operating.	No action.

5.3.4 OPERATION

Sequence of events once the boiler has been correctly installed with the room thermostat and burner turned off.

Event	Result
Turn on electrical power to the boiler	Controller powers up and completes test procedure. Pump starts up. Flow indicator on.
Turn on room thermostat Turn controller on.	Ignition sequence begins; checks water flow, high limit and flow temperature against set temperature. Burner lights. Burner indicator on.
Water flow reaches set temperature.	Burner turns off.
Water flow temperature falls 5°C below set temperature.	Burner relights. Burner indicator on.
Water flow temperature reaches 100°C	High limit switch opens, burner shuts down. Pump continues to run.
Controller turned off	Burner shuts down, pump continues to run.
Room thermostat switches off	Burner shuts down, pump continues to run till water temperature drops to 40°C.
Room thermostat switches on	Pump restarts, burner ignites.
Water flow stopped by external control	Flow switch de-activates, burner turns off and pump continues to run. Flow indicator off.
Water flow is reinstated	Flow switch reactivates, burner re ignites. Flow indicator on.

6.0 GAS CONVERSION

6.1 BURNER CONVERSION

Gas type burner conversion

- Turn off the gas at the external gas valve and turn off the power.
- Remove the access panels from all available sides.
- Disconnect internal gas pipe from inlet side of gas valve.
- Remove the four screws holding the burner assembly in position.
- Disassemble burner tray and remove ribbon burners to expose burner injectors.
- Remove burner injectors and replace with the correct sized injectors for the gas.
- Remove regulator screw cap from top of gas valve.
- Turn plastic plug anti-clockwise until fully removed and withdraw spring.
- Insert spring for desired gas type and re-install plastic plug.
- Re-install burner assembly and reconnect gas supply make sure all gas joints are tight and the earth screw is replaced.
- Check gas system for leaks.
- Commence lighting procedure as described above.
- Adjust burner pressure as described above.

6.2 GAS – COMPONENT INFORMATION

Model	Natural Gas		Propane Gas		ULPG Gas	
	Injector size	Burner pressure	Injector size	Burner pressure	Injector size	Burner pressure
H120	1.25mm	0.90 kPa	0.75mm	2.50 kPa	0.75mm	2.00 kPa
H150	1.25mm	0.90 kPa	0.75mm	2.50 kPa	0.75mm	2.00 kPa

6.3 GAS PIPE SIZING TABLES

Natural gas at 1.13 kPa gas meter pressure					
VICTORIA					
Maximum run of copper pipe with average number of fittings					
Model	20 mm	25 mm	32 mm	40 mm	50 mm
H120	4 m	25 m	90 m	260 m	320 m
H150	2 m	14 m	50 m	140 m	320m

1.25 kPa gas meter pressure					
S.A., W.A., some areas N.S.W.					
Maximum run of copper pipe with average number of fittings					
Model	20 mm	25 mm	32 mm	40 mm	50 mm
H120	18 m	85 m	300 m	320 m	-
H150	10 m	45 m	160 m	320 m	-

2.75 kPa gas meter pressure				
N.S.W. some areas, some new areas of Victoria.				
Maximum run of copper pipe with average number of fittings				
Model	15 mm	20 mm	25 mm	32 mm
H120	12 m	100 m	320 +m	-
H150	8 m	65 m	260 m	320 +m

NO allowance has been made for other appliances connected to the gas main. This information is supplied as an indication of the capacities only. Refer to the latest issue of AG601 for full details.

7.0 TROUBLESHOOTING

BOILER WILL NOT LIGHT	
Possible cause	Remedy
Automatic ignition system fails	Check water flow light indicator.
Pump not running	Check pump and flow switch
Pump air locked	Air bleed system & pump bearing
Flow switch open	Check continuity
Defective gas control	Shut off gas supply and call for service
Thermostat turned off	Turn on
Set temperature lower than water temperature	Increase set temperature
Water too hot-fault condition displayed	Refer to fault indication table
High Limit Thermostat open	Reset
Insufficient water flow	Check for too many valves turned off
BOILER MAKING KNOCKING NOISES	
Possible cause	Remedy
Boiler operating after pump has shut off	Shut off gas supply and call for service
Heat exchanger scaled	Shut off gas supply and call for service

If the boiler cannot be made to perform correctly, please contact the Hurlcon Service Office closest to you.

For	VICTORIA:	Phone (03) 9765 9765
	NEW SOUTH WALES:	Phone (02) 9674 8544
	QUEENSLAND:	Phone (07) 3393 3233
	SOUTH AUSTRALIA	Phone (08) 8345 5755
	WESTERN AUSTRALIA	Phone (08) 9258 9322

For all other areas, please contact our Victorian office.

8.0 H120 – H150 WIRING DIAGRAM

8.1 MODEL H120 – H150 WITH HEATSAVER

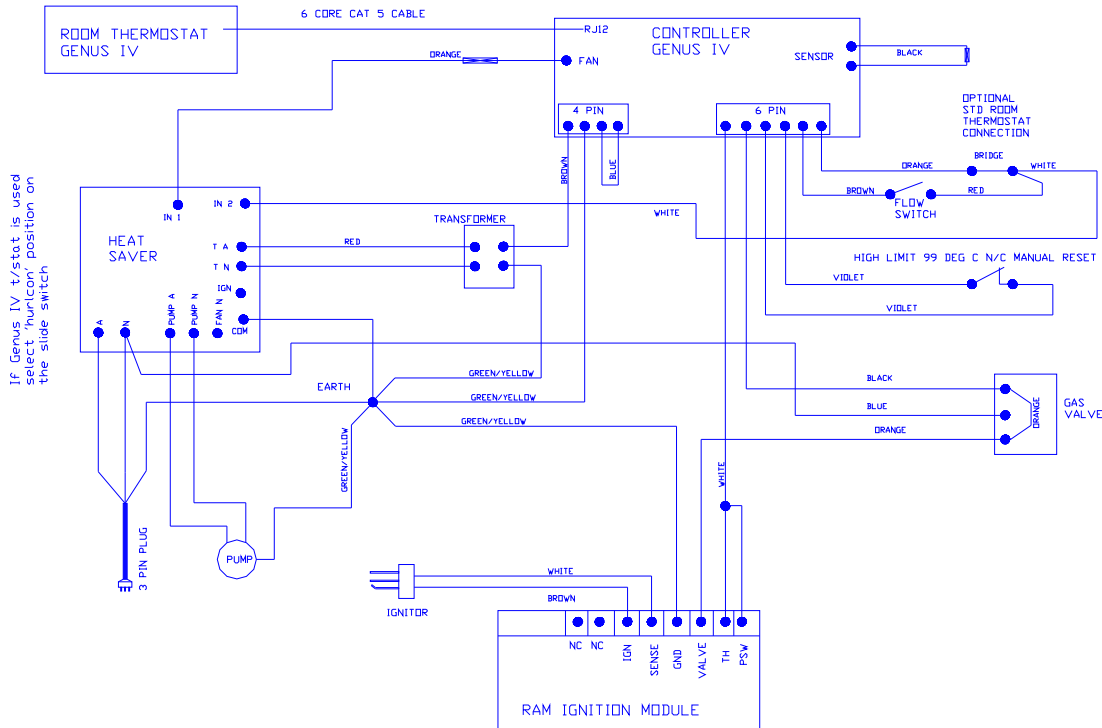

8.2 55 – 90 DEGREE SETTING & THERMOSTAT SELECTION

By changing the jumper position the boiler maximum setpoint can be altered from 90° to 55°. This should be done prior to start up, however if this is done after power has been applied to the boiler un-plugging and reconnecting power will ensure the correct setting. This is located on the rear of the Genus control board at the front of the Boiler.

If the optional Hurlcon Genus room thermostat is used the thermostat selector switch is required to be set to the correct position. This switch is located at the rear of the electrical panel within the boiler cabinet as shown.

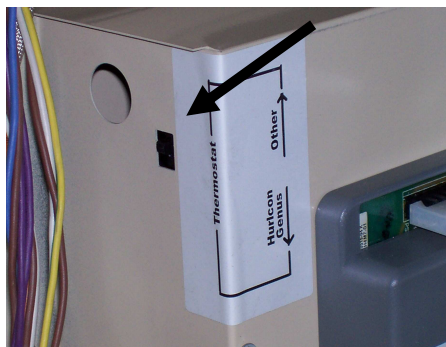
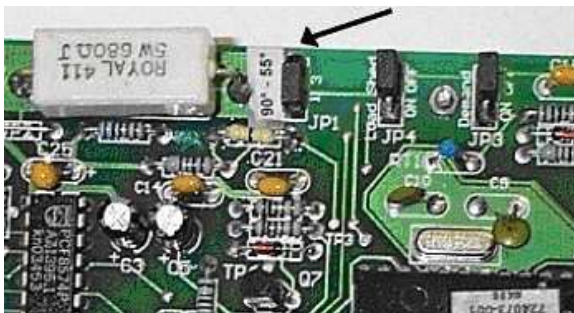

9.0 ONE YEAR LIMITED WARRANTY

GENERAL CONDITIONS

Hurlcon cover your boiler with a limited 1 year warranty against defective materials and workmanship from the date of purchase (plus 30 days to allow for installation). The heat exchanger, burner and cabinet are covered by a five year limited warranty (plus 30 days to allow for installation). Proof of purchase date must be provided in order to substantiate warranty claim.

The warranty includes in field labour costs where the boiler is installed in a capital city metropolitan area. Labour charges apply to boilers installed outside of these areas. Any costs for transport of faulty or replacement parts, removal or reinstallation are the owner's responsibility.

Hurlcon assumes no liability for consequential damages of any kind.

Like your motor vehicle, your new boiler requires periodic service and maintenance to keep it operating in top condition and at maximum efficiency. An annual service by one of our qualified service technicians is highly recommended.

LIMITATIONS

All warranties only apply if the boiler is installed and operated in complete compliance with the installation and operating instructions. The warranty shall not apply to any boilers or parts that have been subject to accident, negligence, alteration, abuse or misuse.

ADDITIONAL WARRANTY EXCLUSIONS:

This warranty does not cover failures or malfunctions resulting from:

- Failure to properly install, operate or maintain the boiler in accordance with our printed instructions provided.
- Abuse, alteration, accident, fire, flood and the like. Examples of misuse or neglect include, but are not limited to, physical damage from external force, not following installation instructions, leaving door off for extended periods of time, inappropriate application of the boiler, etc.
- Scaling, freezing, or other conditions causing an inadequate water circulation.
- Incorrect gas pressure or gas supply.
- Incorrect or excessive flow rate of water.
- Failing to correctly bleed water system of air.
- Chemical contamination of combustion air or use of chemical additives to the water.
- Printed Circuit Boards: This item is warranted against all claims except for power surges, lightning strikes, wilful damage or water damage

No person is authorised to make any warranties on Hurlcon's behalf. To place a service call, contact your nearest Hurlcon office.

Hurlcon Manufacturing & Sales Pty. Limited

Victoria:	New South Wales:	Queensland:	South Australia:	Western Australia:
Ph: (03) 9554 2275	Ph: (02) 9674 8544	Ph: (07) 3393 3233	Ph: (08) 8345 5755	Ph: (08) 9258 9322
Fax: (03) 9554 2272	Fax: (02) 9674 8522	Fax: (07) 3393 3255	Fax: (08) 8345 5211	Fax: (08) 9258 9344

Website: www.hurlcon.com.au

Email: service@hurlcon.com.au